

RECTANGULAR EXTENSION AERIAL® COUCH – SHORT VERSION

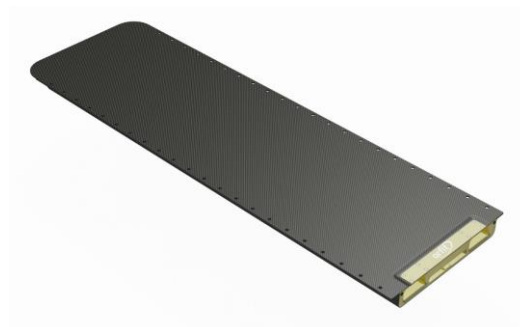

Article No. : 25000/53

A. GENERAL PRODUCT INFORMATION

The product referred to in these instructions is a medical device, used for patient positioning and immobilisation in radiation therapy. This low density base plate is suitable for proton therapy treatments.

This product may only be used in combination with immobilisation solutions produced by Orfit. Orfit prohibits the use of unauthorised third-party products in conjunction with its own products.

B. PRODUCT DESCRIPTION

This carbon fibre extension BASE PLATE is used as an extension for the ORFIT® AERIAL COUCH TOP. Any Orfit immobilisation products can be indexed onto the rectangular extension to reproducibly position a patient for any type of treatment. Information on these other parts can be found in the respective 'instructions for use' and on www.orfit.com.

C. PRECAUTIONS FOR USE

- This is a fragile product, please handle with care.
- Use this base plate as an extension only.
- Always fix the extension securely to the couch before positioning a patient or additional equipment. More information on how to fix this extension to the couch top can be found in this document.
- Do not lean or sit on the outer end, beyond the 'NO SITTING' line. Have the patient sit on the pedestal area first (or below the 'NO SITTING' line) and then slide cranially to lay down. Make sure the patient is never mounting on the base plate by sitting on his or her knees. This might damage the base plate.



NO SITTING



- Take into account the maximum weight loads.
- The carbon fibre base plate is constructed to be light in weight. When handled roughly, it may get damaged and fibres may come off. When this happens, stop using the base plate to prevent fibres from getting in contact with the patient's or user's skin. Contact your distributor, local product specialist or sales representative.
- Always be careful where to hold the extension when lifting, moving or (un)locking it. Since the board is bottom-heavy – and very light at the patient side – it is unbalanced. Therefore; always place your hands at the location of the 'hands here' pictogram labels which are placed around the centre of gravity.



- Do not use the extension after it had a severe collision with the ground, wall/door or other device in the room. A collision might compromise the strength of the internal structure and could result in failure.
- The article number and lot number can be found on the back of the base plate. They are mentioned on the bottom side of the plate in between 2 indexing holes at the edge (caudal side).

- In case there are any uncertainties about the safe use of this extension, contact your distributor, local product specialist or sales representative.

D. STORAGE

Always store the product in a safe place to prevent it from getting damaged. Take care not to damage the edges of the plate when storing it in an upright position. Prevent hard objects from falling onto the plate. Do not place any items on top of the extension while in storage.

Store the base plate between +10°C (50°F) and 40°C (104°F).

E. PROPERTIES

E.1 Physical Properties

Rectangular Aerial extension – short version without base

Outer dimensions : L 1365 x W 530 x H 65 mm
 : L 53.74" x W 20.86" x H 2.56"
 Weight : +/- 8.9 kg / +/- 19.62 lbs

Rectangular Aerial extension – short version with base

Outer dimensions : L 1920 x W 530 x H 90 mm
 : L 75.60" x W 20.86" x H 3.54"

E.2 Material Properties

The base plate is a composite carbon fibre sandwich. It consists of a core in low density foam which is covered by a thin layer of carbon fibre. Edges are made of a very thin layer of phenolic resin. The interface is made of aluminium with aluminium reinforcement plates and bolts. Other inserts are made from phenolic.

This base plate is labelled 'MR Unsafe' due to the used metallic and carbon fibre materials. This is visualized by the following label:



E.3 Mechanical Properties

Max. allowed distributed load on full couch (incl. Aerial Couch base part): 235 kg / 518 lbs

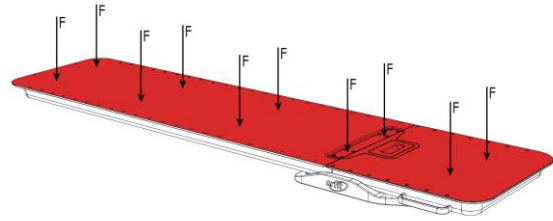

CAUTION

- Prevent point loads at all times!
- The specific load capacity of the robotic system may be less. Please respect the specific safety requirements of the robotic positioning system.
- Make sure to take into account the weight of every item placed on top of the extension and add it to the patient weight to check that the total weight does not exceed the maximum load limit of the couch top.

E.3. Dosimetric Properties

The WET values depend on the location on the extension. The values given below are for proton therapy.

Location	WET (cm) at 170 MeV
1	0.90
2	0.92
3	0.92

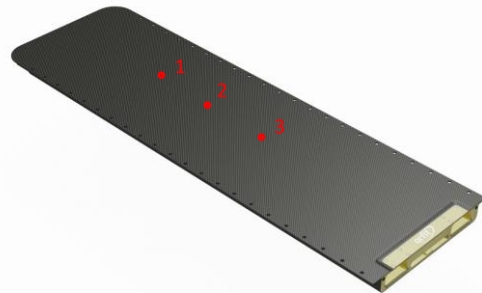

Note: Use these numbers as a guidance only. Perform the measurements again in your department to verify these results.

The attenuation factor for high energy proton beams will be negligible. It is so small that it cannot be measured.

The location where the homogeneous and low density 'treatment zone' starts is marked with the label below:

TREATMENT ZONE

The Base Plate has areas where higher density ($\pm 1.4 \text{ g/mm}^3$) materials have been used. The following image shows these areas inside the red lines.

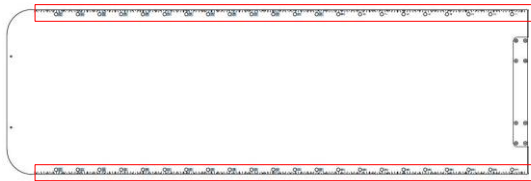

F. ATTACHEMENT TO COUCH

The extension 25000/53 is designed to fit the Aerial Couch for Proton Therapy. Consult the respective user manual of the couch to safely operate the system.

CAUTION

- The couch extension is not allowed to be used on another couch than specified in this document.
- Take into account any precautions and instructions described in the user manual of the couch base.

MOUNTING OF EXTENSION

1. Before mounting the extension, make sure the couch is unlocked and no extension is attached. This can be verified by checking if the handle (1) of the Aerial couch base is in upright position (see below).

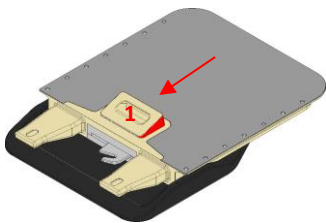

2. Grab the extension at the sides and hold the extension in front of the tabs (2) and make sure the tabs are positioned within the opposite cavities.

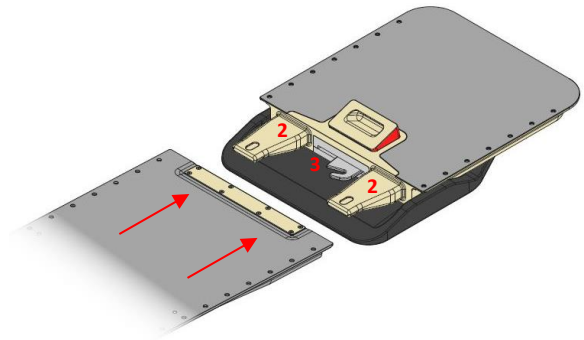

3. Slide the extension towards the base. By sliding the extension towards the base, the latch plate (3) will turn into the locked position. The release handle (1) – which is connected with the locking pin – will fall down into the locking position.

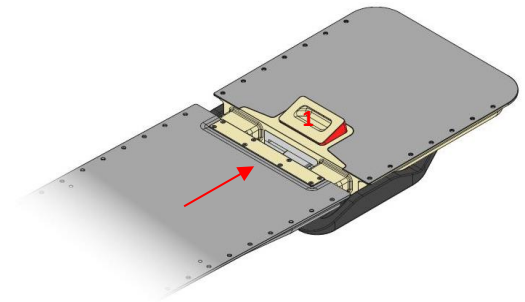

4. When the handle surface is flush with the top surface of the couch (the red unlock sign is not visible), and when there is a small seam of +/- 1 mm between the couch and the extension, then the couch extension is correctly secured to the couch base.

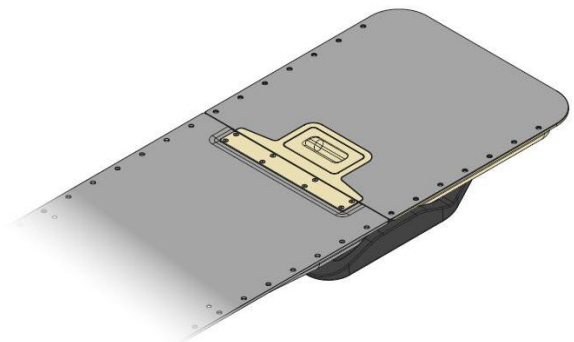

DISMOUNTING OF EXTENSION

1. Pull the release handle (1). By pulling the release handle (1), the latch plate will be actuated and unlocked. The handle will stay in the upright position, showing an 'unlocked' sign at the sides.

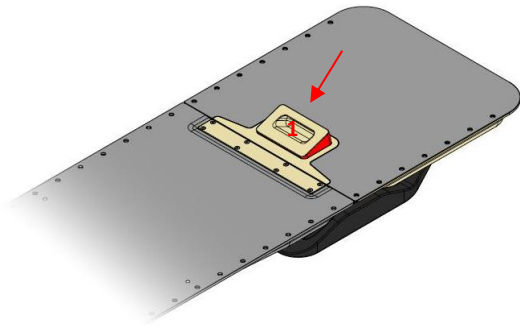

2. Grab the extension and slide it outwards – in longitudinal direction – away from the couch base part.

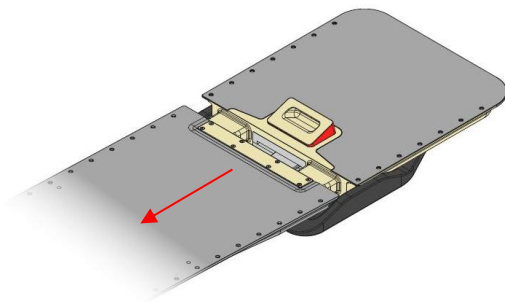

3. When reaching the stop (second safety mechanism), lift the extension slightly. **Make sure you hold the extension around the 'hand' pictogram stickers with two hands because the extension is heavier towards the bottom!** The weight of the extension is not evenly distributed

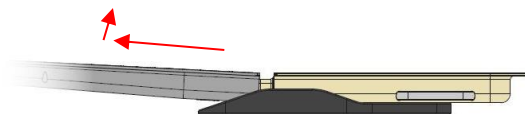

4. Remove the extension from the tabs (2).

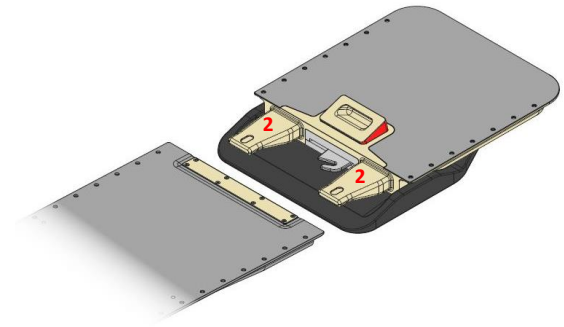

5. Store the extension safely in a storage cart or against the wall to make sure it will not get damaged.

CAUTION

1. Never try to force the handle downwards because it might be blocked by the safety mechanism. It should lock by itself when moving the extension towards the end position.

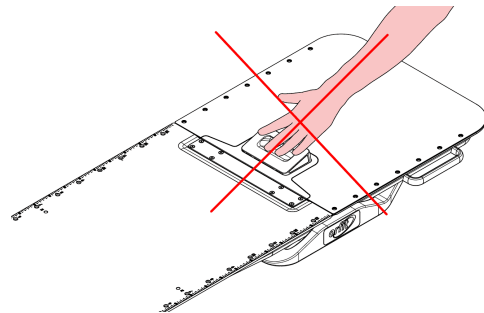

2. Once the release lever is pulled upwards, you have to remove the extension completely (!) from the tabs before you can lock it again.
3. Always verify that the extension is securely fixed by checking if it is flush with the couch (horizontal), if the handle is flush and if there is a seam between couch and extension of about 1 mm.

G. ACCESSORIES FOR THE EXTENSION PLATE

Any Orfit immobilisation products can be indexed onto the rectangular extension – short version for the aerial couch. To define the appropriate fixation devices, consult the fixation device finder on www.orfit.com.

Information on these products can be found in the respective 'instructions for use' and on www.orfit.com.

H. MAINTENANCE AND WASTE MANAGEMENT

This product can be cleaned and disinfected by means of an isopropanol based disinfectant, applied with a soft cloth. If unsure about the cleaning fluid, do not use. **Never use aerosol sprays, corrosive cleaning agents, solvents or abrasive detergents.** Further cleaning instructions can be found in the [Orfit Cleaning Guidelines](#). The product can be disposed of with household waste.

Periodic checks of the product should be done to insure safe use.

Weekly:

- No damages (cracks/dents) of any kind which might indicate a collision occurred.

- No visible defects on the aluminium adapter.
- All bolts still firmly in place.
- No delamination of carbon top and bottom layers.
- Two 'Secondary Locking Pins' still in place inside the aluminium adapter.

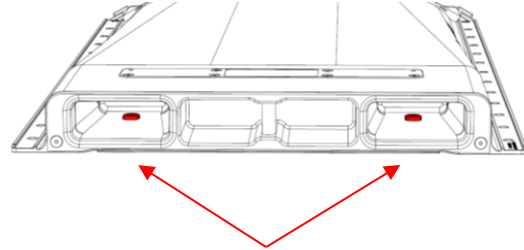

Immediately stop using the extension if a defect is found. **Do not attempt to make repairs yourself.** Also make sure to respect and perform the maintenance procedures of the Aerial couch base. These can be found in the respective 'Instructions For Use'. Contact your distributor if there are any questions or concerns.

I. ADDITIONAL INFORMATION

For additional information such as distributor contact information, product brochures, Safety Data Sheets and regulatory information, please visit our website www.orfit.com.

Note:

It is prohibited to make alterations to this text without prior approval from Orfit Industries. Aerial® is a registered trademark of Orfit Industries NV.



ORFIT INDUSTRIES
Vosveld 9A | B-2110 Wijnegem | Belgium
T (+32) (0)3 326 20 26
welcome@orfit.com

www.orfit.com



Ref. No. 50227
VERSION 1
LAST UPDATE: 15/04/2021
REVISION DATE: 15/04/2023